



CUSTOMER NAME:

PROJECT LOCATION:

DRAWING DESCRIPTION:

8' x 8' MODULAR OFFICE

PROJECT TYPE:

INTERIOR

sales@unitedpartition.com

P: (800) 959-0878

F: (909) 947-2675

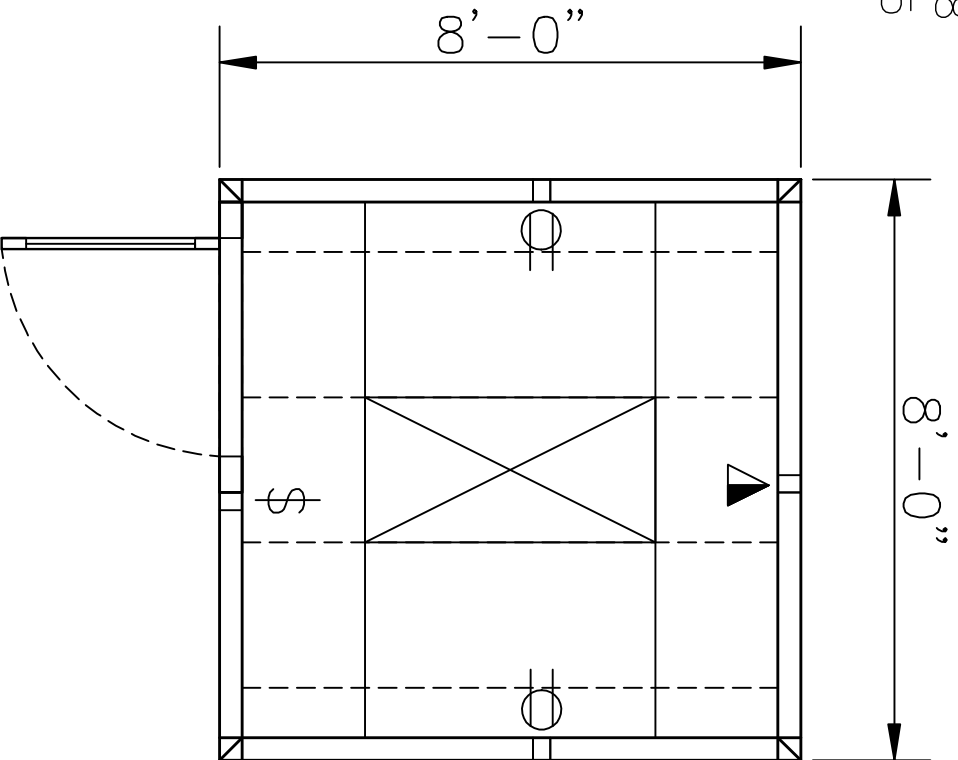

OPTIONS:

R-19 BATT CEILING INSULATION

WINDOWS

INCREASED WALL HEIGHT 9'  10'

WALL MOUNT HVAC UNIT

BREAKER PANEL

WINDOW

W

NEW MODULAR WALL



PHONE/DATA (NO WIRING)



110V DUPLEX



LIGHT SWITCH



LIGHT FIXTURE

